

Product Description

- Cable management solution
- Supports easy installation, moves, additions and changes
- Cable friendly design, no sharp edges
- Up to 100% visual cable loading
- Approved for all types of cables
- Mechanical system for easy installation
- For fire and smoke barriers
- Fire rated by design, no firestop handling
- Compliant all the time

Ordering Information



EZD44T 2.67 4

Applications

- For all types of cables (max ø80mm)
- Rigid walls, flexible walls and rigid floors

Technical Data

Fire Resistance (EN 1366-3)	2 Hours
Classification (EN 13501-2)	EI 120
Reaction To Fire (EN 13501-1)	Class E
Sound Insulation (ASTM E90)	STC 54 (Relates to specific construction)
Air Leakage (UL1479)	1.57 m3/h for 0% cable 3.24 m3/h for 100% cables
Durability and Serviceability	Type Y ₂

Firestop Handling

No handling required for fire safety compliance.

EZD44T

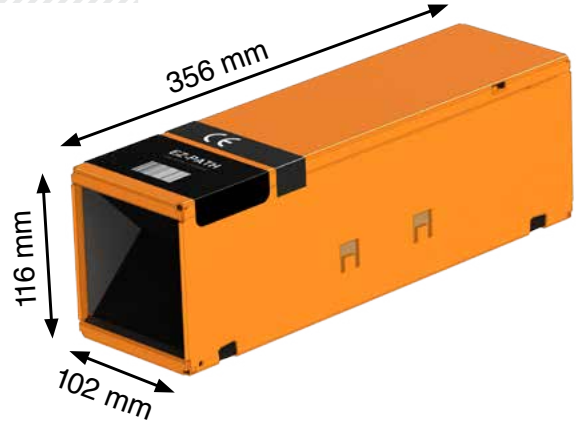

Fire Barrier



Smoke Barrier



Intumescent



Re-Enterable



Finished Product



Noise Reduction

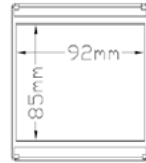

Cable loading

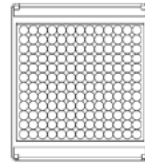

Ø7mm cable
156x

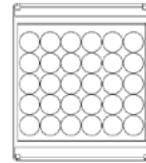

Ø15mm cable
30x

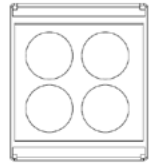

Ø35mm cable
4x

Shell Composition:	1.5 mm Thick Galv. Steel
Expansion Begins:	177°C
Volume Expansion:	800%
In-Service Temperature:	Not To Exceed 49°C
Shelf Life:	No Limit
VOC Content: ASTMD3960 OR EPA Method 24	None

Approvals

European Technical Approval ETA – 0887/13



0843



EZD44T

Plate Kits

EZP144WT



EZP544WT

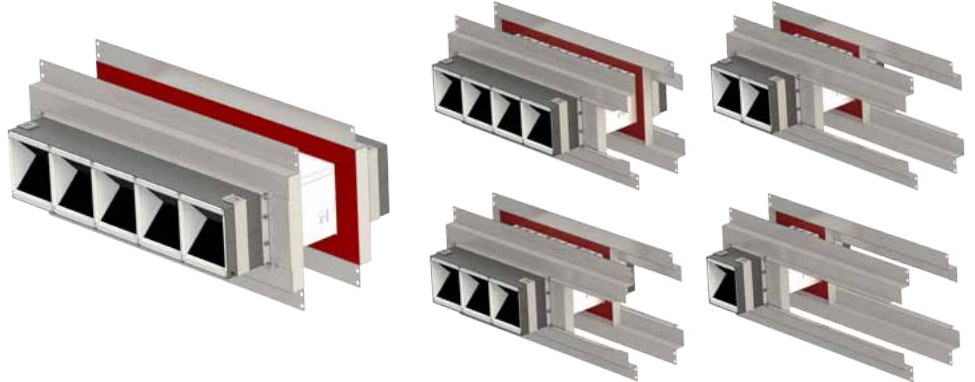

EZG144T



EZG444T

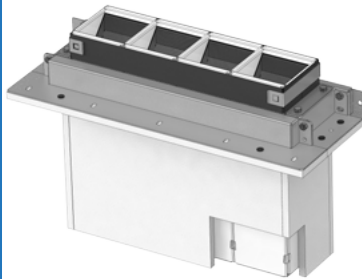

EZG844T

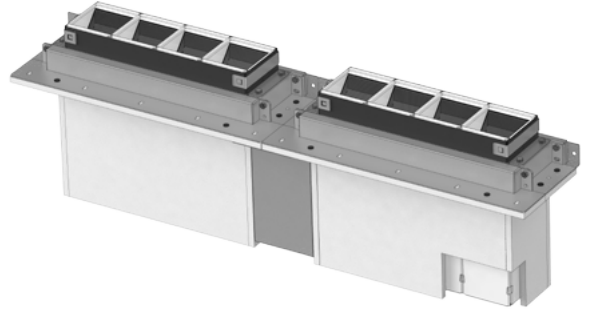
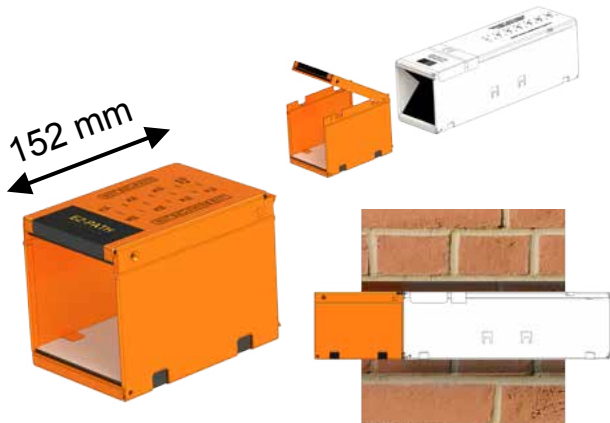

Plate kits to be ordered separately.

Accessories

EZD44ES



RCM44

